

Operation Manual

APC™ Smart-UPS™ Ultra

SRTL5KRM2UI
SRTL5KRM2UT
SRTL5KRM2UJ

200/208/220/230/240 Vac

Tower/Rack-Mount 2U

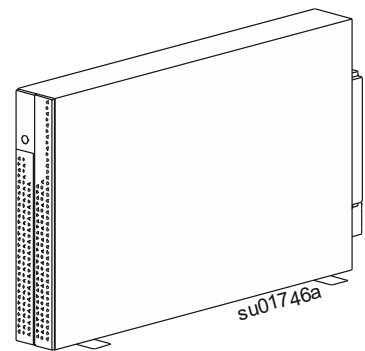
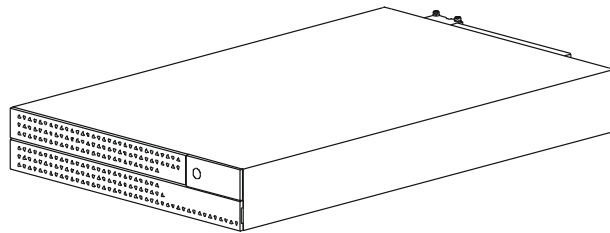

Life Is On

Schneider
Electric

General Information

Important Safety Instructions

SAVE THESE INSTRUCTIONS - This manual contains important instructions that should be followed during installation and maintenance of the Smart-UPS and batteries.

Read these instructions carefully and look at the equipment to become familiar with the device before trying to install, operate, service or maintain it. The following special messages may appear throughout this bulletin or on the equipment to warn of potential hazards or to call attention to information that clarifies or simplifies a procedure.



The addition of this symbol either to a “Danger” or “Warning” safety label indicates that an electrical hazard exists which will result in personal injury if the instructions are not followed.



This is the safety alert symbol. It is used to alert you to potential personal injury hazards. Obey all safety messages that follow this symbol to avoid possible injury or death.

DANGER

DANGER indicates a hazardous situation which, if not avoided, **will result in** death or serious injury.

WARNING

WARNING indicates a hazardous situation which, if not avoided, **could result in** death or serious injury.







CAUTION

CAUTION indicates a hazardous situation which, if not avoided, **could result in** minor or moderate injury.

NOTICE

NOTICE is used to address practices not related to physical injury.

Product Handling Guidelines

	<18 kg <40 lb		18-32 kg 40-70 lb		32-55 kg 70-120 lb		>55 kg >120 lb		
---	---------------------	---	-------------------------	---	--------------------------	--	----------------------	---	---

Safety and General Information

- Adhere to all national and local electrical codes.
- All wiring must be performed by a qualified electrician.
- Changes and modifications to this unit not expressly approved by Schneider Electric could void the warranty.
- This UPS is only for Professional Business Applications and not for Consumer Applications.
- This UPS is intended for indoor use only.
- This UPS must be installed in dedicated IT environments only.
- Do not operate this UPS in direct sunlight, in contact with fluids, or where there is excessive dust or humidity.
- Be sure the air vents on the UPS are not blocked. Allow adequate space for proper ventilation.
- For a UPS with a factory installed power cord, connect the UPS power cable directly to a wall outlet. Do not use surge protectors or extension cords.
- The equipment is heavy. Always practice safe lifting techniques adequate for the weight of the equipment.
- The battery modules are heavy. Remove the battery modules before installing the UPS and external battery packs (XLBPs), in a rack.
- Be sure that the depth of the rack is at least 1000 mm.
- Maintain a clear space of 300 mm (minimum) from the front and back surfaces of the UPS to any adjacent surface.
- Always install XLBPs at the bottom in rack-mount configurations. The UPS must be installed above the XLBPs.
- Always install peripheral equipment above the UPS in rack-mount configurations.
- Additional safety information can be found in the Safety Guide supplied with this unit.
- This UPS must be serviced by service personnel or a qualified electrician.
- Connect only SELV circuits to all the communication ports.

Deenergizing safety

- The UPS contains internal battery modules and may present a shock hazard even when disconnected from AC and DC power.
- Before installing or servicing the equipment check that the:
 - Mains circuit breaker is in the **OFF** position
 - Internal UPS battery modules are removed
 - XLBP battery modules are disconnected

Electrical safety

- For models with a hardwired input, the connection to the branch circuit (mains) must be performed by a qualified electrician.
- 2UI models only: In order to maintain compliance with the EMC directive for products sold in Europe, output cords attached to the UPS must not exceed 10 meters in length.
- The protective earth conductor for the UPS carries the leakage current from the load devices (computer equipment). An insulated ground conductor is to be installed as part of the branch circuit that supplies input power to the UPS. The conductor must have the same size and insulation material as the grounded and ungrounded branch circuit supply conductors. The conductor will typically be green and with or without a yellow stripe.
- The UPS input ground conductor must be properly bonded to protective earth at the service panel. If the UPS input power is supplied by a separately derived system, the ground conductor must be properly bonded at the supply transformer or motor generator set.

Battery safety



WARNING

RISK OF CHEMICAL HAZARD AND EXCESSIVE SMOKE

- Replace the battery modules at least every 10 years or at the end of its service life, whichever is earlier.
- Replace the battery modules immediately when the UPS indicates battery replacement is necessary.
- Replace the battery modules with the same number as originally installed in the equipment.

Failure to follow these instructions can result in death or serious injury.

- Schneider Electric uses Lithium Ion batteries. Under normal use and handling, there is no contact with the internal components of the battery.
- The replaceable battery module (RBM) typically lasts for 10 years. Environmental factors impact battery life. Elevated ambient temperatures, poor quality mains power causing frequent short duration discharges will shorten battery life.
- CAUTION: Before installing or replacing the RBM, remove conductive jewelry such as chains, wrist watches and rings. High energy through conductive materials could cause severe burns.
- CAUTION: Do not place or use the RBM or XLBP near heat or fire. Do not crush, do not dispose off a RBM or XLBP in a fire. The batteries may explode..
- CAUTION: Do not open the enclosure of RBM. Doing so will expose the cell terminals which pose an energy hazard.
- CAUTION: Do not open the RBM or mutilate the cells inside. Released chemical is harmful to the skin and eyes. It may be toxic.
- CAUTION: RBM can present a risk of electric shock and burns by high short-circuit current.
- CAUTION: Failed RBMs can reach temperatures that exceed the burn thresholds for touchable surfaces.
- Do not use a dropped, damaged or deformed RBM.
- Do not short circuit the RBM.
- Do not drive nails into the RBM.
- Do not strike the RBM with a hammer.
- The XLBPs should be replaced by qualified personnel only.
- The RBMs can be replaced by the user.
NOTE: Live swap of RBM should be performed by qualified personnel only.

Hardwire safety

- Verify that all branch circuit (mains) and low voltage (control) circuits are de-energized, and locked out before installing cables or making connections, whether in the junction box or to the UPS.
- Wiring must be done only by a qualified electrician.
- Check national and local codes before wiring.
- Strain relief is required for all hardwiring (supplied with select products). Snap in type strain reliefs are recommended.
- All openings that allow access to UPS hardwire terminals must be covered. Failure to do so may result in personal injury or equipment damage.
- Select wire size and connectors according to national and local codes.

General information

- The UPS will recognize as many as 10 XLBPs connected to the UPS.
NOTE: For each XLBP added, recharge time will increase.
- The model and serial numbers are located on a top cover label. For some models, an additional label is located on the chassis under the front bezel.
- Always recycle used RBMs.
- Recycle the package materials or save them for reuse.

FCC Class A Radio Frequency Warning

NOTE: Applicable only for SRTL5KRM2UT model)

This equipment has been tested and found to comply with the limits for a Class A digital device, pursuant to part 15 of the FCC Rules. These limits are designed to provide reasonable protection against harmful interference when the equipment is operated in a commercial environment. This equipment generates, uses, and can radiate radio frequency energy and, if not installed and used in accordance with the instruction manual, may cause harmful interference to radio communications. Operation of this equipment in a residential area is likely to cause harmful interference in which case the user will be required to correct the interference at his own expense.

VCCI-A Caution

NOTE: Applicable only for SRTL5KRM2UJ model

この装置は、クラスA機器です。この装置を住宅環境で使用すると電波妨害を引き起こすことがあります。この場合には使用者が適切な対策を講ずるよう要求されることがあります。

VCCI-A

SUR115a

Product Overview

The APC Smart-UPS™ Ultra SRTL is a high performance uninterruptible power supply (UPS). The UPS helps to provide protection for electronic equipment from utility power blackouts, brownouts, sags, surges, small utility power fluctuations and large disturbances. The UPS also provides battery backup power for connected equipment until utility power returns to acceptable levels or the batteries are completely discharged.

This user manual is available on the APC web site, www.apc.com.

Specifications

For additional specifications visit our web site, www.apc.com.

Environmental

Temperature	Operating	0 to 40 °C (32 to 104 °F)
	Storage	-15 to 45 °C (5 to 113 °F)
Maximum Elevation	Operating	0 - 3,000 m (0 - 10,000 ft)
	Storage	0 - 15,000 m (50,000 ft)
Humidity	0% to 95% relative humidity, non-condensing	
International Protection Code	IP20 rating	
Pollution Degree (Applicable only for SRTL5KRM2UI model)		PD2
NOTE:		
<ul style="list-style-type: none"> • Charge the RBMs immediately upon receipt / first installation and at least once in nine months during storage or when not in use. • Environmental factors impact battery life. Elevated ambient temperatures, high humidity, poor quality mains power causing frequent short duration discharges will shorten battery life. 		

Physical

The UPS is heavy. Follow all lifting guidelines.	
Unit weight without batteries and without packaging (approx.)	19 kg
Unit dimensions without packaging Height x Width x Depth	89 x 432 x 768 mm (3.5 x 19 x 30.25 in)
Unit dimensions with packaging Height x Width x Depth	984 x 585 x 392 mm (38.74 x 23.03 x 15.43 in)

Battery

Battery type	Lithium-Ion
Replacement battery module This UPS has replaceable battery modules. Refer to the appropriate replacement battery user manual for installation instructions. Contact your dealer or go our web site, www.apc.com for information on replacement batteries.	SRYLBM
Number of battery modules	1 battery module
Voltage for each battery module Total voltage for the UPS Ah rating	180 V 180 V 4 Ah per battery module Usable: 2.47 Ah

Battery module	UPS	XLBP
SRYLBM	SRTL5KRM2UI	SRTL180RM2UBP
	SRTL5KRM2UT	
	SRTL5KRM2UJ	SRTL180RM2UBPJ

NOTE: The LED present on the front panel of the battery pack illuminates **Green** if the battery pack is healthy and communication is enabled else it illuminates **Red**.

Electrical

CAUTION: To reduce the risk of fire, connect the UPS only to a circuit provided with recommended maximum branch circuit overcurrent protection in accordance with the National Electrical Code, ANSI/NFPA 70 and the Canadian Electrical Code, Part I, C22.1.

Models	Rating		Branch Circuit Overcurrent Rating / Building Circuit Breaker (CB) Current Rating
	Online	Green Mode	
SRTL5KRM2UI	5 kVA / 5 kW	5 kVA	40 A
SRTL5KRM2UT	208 V	4.9 kVA / 4.9 kW	30 A
	240 V	5 kVA / 5 kW	
SRTL5KRM2UJ	5 kVA / 4.6 kW	5 kVA	

NOTE: The following specifications are applicable only for SRTL5KRM2UI model.

Over Voltage Category	OVC II
Applicable power grid power distribution system	TN Power System
Applicable Standard	IEC 62040-1

Output

Model	SRTL5KRM2UI	SRTL5KRM2UT	SRTL5KRM2UJ
Output Frequency	50/60 Hz \pm 3 Hz		
Nominal Output Voltage	220/230/240 VAC	208/240 VAC	200 VAC

Input

Model	SRTL5KRM2UI	SRTL5KRM2UT	SRTL5KRM2UJ
Input Frequency	40 to 70 Hz \pm 0.1 Hz		
Nominal Input Voltage	220/230/240 VAC	208/240 VAC	200 VAC

Front panel features - UPS

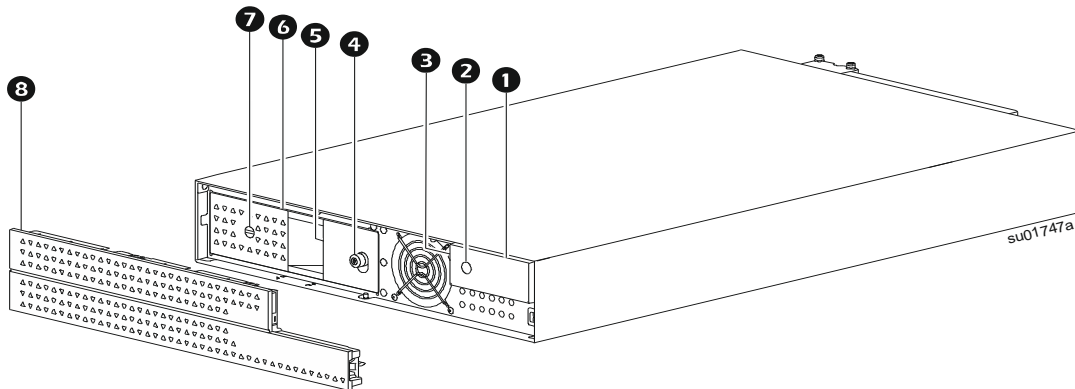

① LCD Display	⑤ Battery status LED (located behind the battery handle)
② POWER ON button	⑥ Battery module
③ UPS Status LED Indicator (located on the side wall of the LCD display)	⑦ BATTERY ON/OFF switch
④ Thumbscrew	⑧ Bezel

Rear panel features - UPS

Note: Refer to the table “Key to identify rear panel features” on page 7, that provides a key to the callout numbers for the rear panel graphics depicted in this manual.

SRTL5KRM2UI

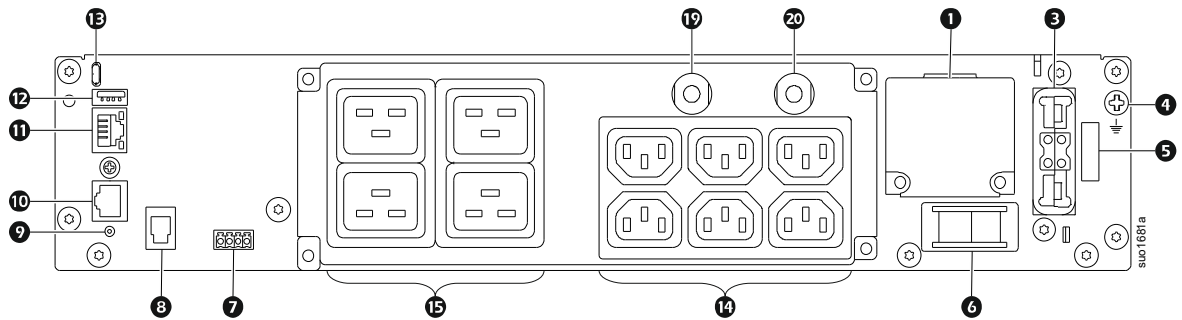

SRTL5KRM2UT

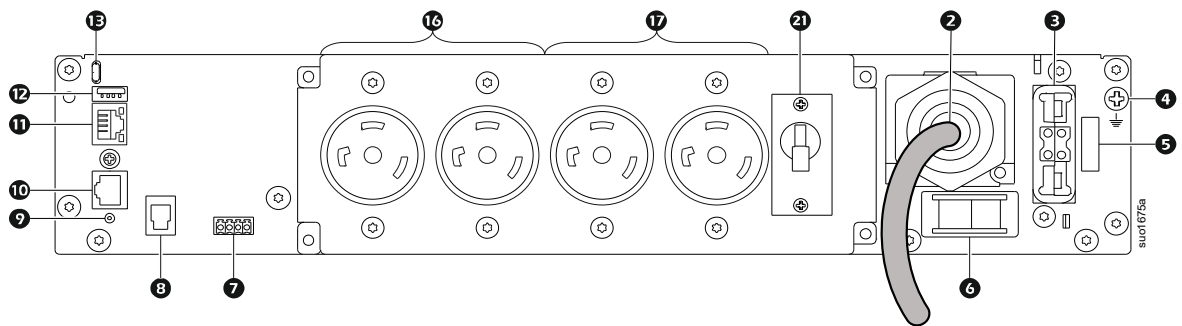

SRTL5KRM2UJ

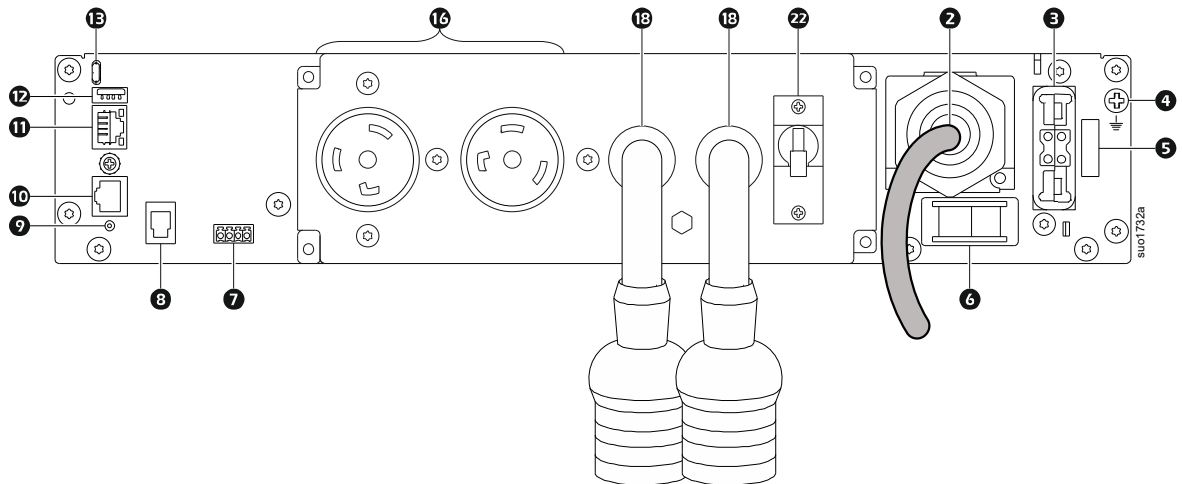

NOTE: The above illustration is only for reference. The actual location of the rear panel features may vary depending on the model.

Key to identify rear panel features

1	Hardwire input terminal box	Hardwire the mains input.
2	AC input power cord	Connect the power cord to AC Mains.
3	External battery pack receptacle	Connect external battery pack(s) for extended run time. The UPS will automatically recognize up to 10 external battery packs.
4	Chassis ground	For ground connection of the XLBP.

5	Safety Interlock Switch	Battery Enable/Disable switch
6	System Enable Switch	System Enable/Disable switch.
7	EPO terminal	Emergency Power Off (EPO) terminal allows the user to connect the UPS to a central EPO system.
8	External battery pack communication port	Communication between XLBP and UPS.
9	RESET switch	Use this switch to reset network management interface.
10	Universal I/O port	Use to connect: <ul style="list-style-type: none"> • Temperature sensor AP9335T (supplied) • Temperature/humidity sensor AP9335TH (not supplied) • Relay input/output board AP9810 (not supplied).
11	Network port	Use the Network port to connect the UPS to the network. NOTE: Use a shielded cable for this connection.
12	Host USB port	For a USB Flash Drive.
13	Console port	Use the Console port to configure the network management features.
14	IEC C13 outlets	Connect electronic devices to these outlets.
15	IEC C19 outlets	
16	L6-30R outlets	
17	L6-20R outlets	
18	Pigtail with L6-20R outlets	
19	16 A output circuit breaker for IEC C19 outlets	Protects outlets in the event an overload condition occurs. Connected load should be lower than the circuit breaker capacity.
20	10 A output circuit breaker for IEC C13 outlets	
21	20 A output circuit breaker for L6-20R outlets	
22	20 A output circuit breaker for pigtail with L6-20R outlets	

Rear Panel Features - XLBP

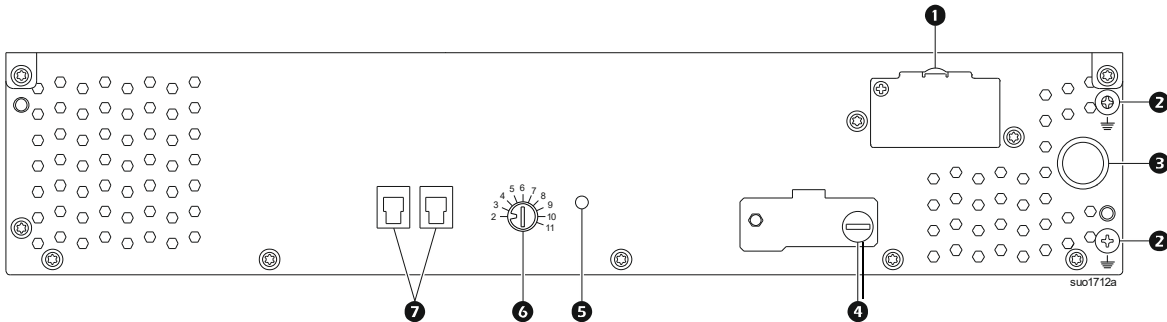

1	Battery receptacle	Connect the battery connection cable from an additional XLBP to this receptacle.
2	Ground terminal	Connect ground wires to this terminal. Refer “Connect the ground cable” on page 9 for details.
3	Battery connection cable	Connect the cable to the battery connection receptacle on the rear panel of the UPS.
4	XLBP ENABLE switch	Turn the thumbscrew clockwise completely, to enable communication between the XLBP and UPS.
5	XLBP Status LED	Illuminates green to indicate communication status between the XLBP and UPS is enabled.
6	XLBP ID SELECTOR switch	Set a unique ID for each XLBP connected, using this switch (do not set the same unique ID for multiple XLBPs).
7	Battery communication port	Connect the communication cable from the UPS or from an additional XLBP to this port.

Connect External Battery Pack (XLBP)

UPS model may differ in appearance from those depicted in the below illustrations. The process is identical for all models.

Connect the ground cable

1. Locate and remove the ground screw on the rear panel of both the UPS and XLBP.
2. Secure cable lug on one end of the ground wire to the ground terminal on the UPS and the cable lug at the other end to the ground terminal on the XLBP with the screw removed in *step 1*.

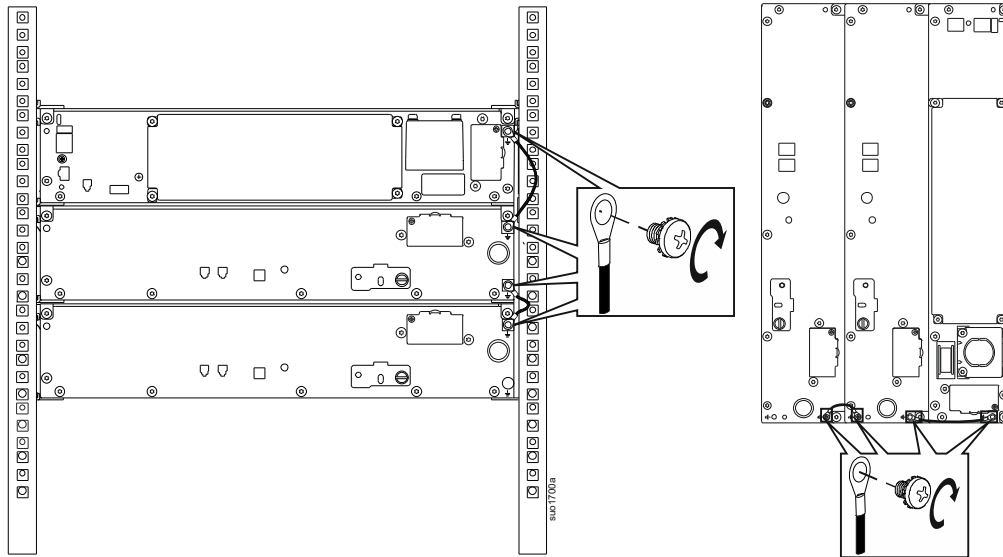

Connect a single XLBP to UPS

<p>1 Remove the battery receptacle protection cover in the UPS</p>	
<p>2 Connect the battery connector and communication cable</p>	
<p>1 Battery communication cable 2 Battery connector cable</p>	

Connect multiple XLBPs to UPS

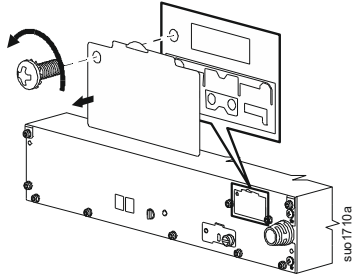
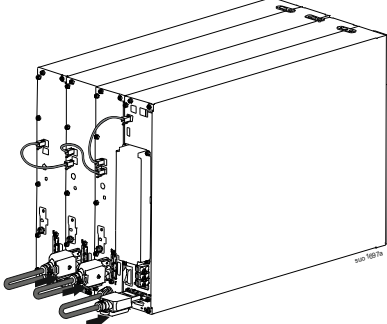
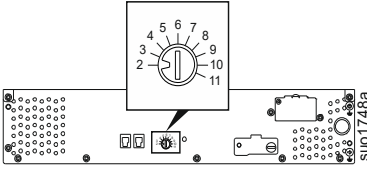
<p>1 Connect the first XLBP to the UPS. Refer “Connect a single XLBP to UPS” on page 9 for details.</p>	
<p>2 Remove the battery receptacle protection cover in the XLBPs</p>	
<p>3 Connect the battery connector and communication cable</p>	
<p>4 Set unique identification (ID) number for each XLBP connected</p> <p>Set the unique identification (ID) number on the XLBP ID SELECTOR Switch for each XLBP. The position of the notch on the dial indicates the set unique ID number.</p> <p>NOTE: Set unique ID for each XLBP.</p>	

Operation

Connect Equipment

CAUTION

RISK OF ELECTRIC SHOCK

- Disconnect the mains input circuit breaker before installing or servicing the UPS.
- Disconnect RBM and XLBPs before installing or servicing the UPS.
- The UPS contains RBM and XLBP that may present a shock hazard even when disconnected from the mains.
- UPS AC hardwired and pluggable outlets may be energized by remote or automatic control at any time.
- Disconnect equipment from the UPS before servicing any equipment.
- Do not use the UPS as a safety disconnect.
- Use Snap-In strain reliefs.
- Recommended input terminal screw torque: 16 lbf-in (2 Nm).

Failure to follow these instructions can result in equipment damage and minor or moderate injury

Note: The UPS batteries will charge to 90% capacity in the first three hours of normal operation. **Do not expect full battery runtime capability during this initial charge period.**

1. Connect the RBM. Refer the UPS Installation manual for details.
2. Connect equipment to the outlets on the rear panel of the UPS.
3. Connect the UPS to the building utility power.
4. Be sure that the SYSTEM ENABLE switch located on the rear panel of the UPS is turned on.

Turn the UPS on/off

The first time the UPS is turned on, the **Setup Wizard** screen will run. Follow the prompts to configure UPS settings. Refer to “Configuration” on page 15 for details.

Turn on

UPS turns *on* when utility voltage is applied at the AC input terminals. The Display Interface illuminates and displays a “Wait” screen indicating that the system is getting initialized. This process takes approximately about 1 minute. After successful initialization, user menus will be accessible from the display interface.

To turn the output *on* and supply power to the connected equipment, select Menu icon on the display and select OK. Select Control icon from the next screen and click OK. Select either Turn *on* Immediately / Turn *on* with delay as required and click OK. Output will get turned *on*.

Turn on without Utility Power

UPS can be turned *on* without utility power through cold start. To cold start the UPS, long press (2sec) the POWER ON/OFF button. This powers *on* the battery pack and wakes up the UPS. Display will turn *on* and displays a “Wait” screen indicating that the system is getting initialized. This process takes approximately about 1 minute. After successful initialization, user menus will be accessible from the display interface. To turn the output *on* and supply power to the connected load, select Menu icon on the display and click OK. Select Control icon from the next screen and click OK. Select “Turn *on* with No AC” and click OK. Output should turn *on*.

Turn off

To turn the output power off, select Menu icon on the display and click OK. Select Control icon from the next screen and click OK. Select Turn *off* Immediately/ Turn *off* with delay as required and click OK. Output should turn *off*.

Once the AC power has been turned off, the UPS will continue operating on battery power for a short period of time depending on load and remaining battery capacity. To completely power off the UPS, touch the POWER button on the LCD panel, select *Internal Power Off* and click OK. UPS will power off completely.

UPS Display Interface

①	MENU button	
②	Battery status icon	
③	Battery charging icon	
④	Green mode icon	
⑤	Operation mode icon	
⑥	UP button	
⑦	UPS status information	
⑧	DOWN button	
⑨	MUTE icon	
⑩	Load icon	
⑪	OK button	
⑫	POWER button with LED <ul style="list-style-type: none"> Press the button to wake up the UPS, when it is completely off. A short press of the button will display the control menu. Follow the prompts on the screen to either turn the UPS <i>on/off</i>, immediately or after a delay. Button illumination indications are the same as the Status LED. 	
⑬	Status LED (located on the side of the UPS LCD display interface) <ul style="list-style-type: none"> Not illuminated: UPS output is off. Illuminates green: UPS is on-line mode. Illuminates amber: UPS is in battery mode. Illuminates red: UPS has detected an internal error Flashes red every 2 seconds: UPS is on-line mode and battery is disconnected. 	

LCD display interface rotation

The orientation of the LCD display interface gets adjusted automatically based on UPS orientation.

Rack-mount	Tower

UPS Display Interface operation

The UPS display interface is a touchscreen interface.

Touch on the icon to activate the key function.

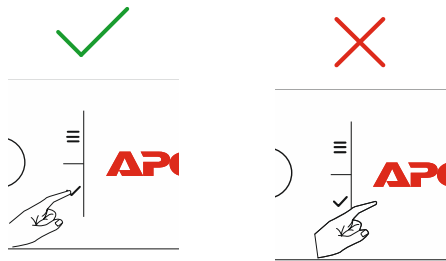

Use the UP/DOWN buttons to scroll through the options. Touch the OK button to accept the selected option. Touch the ESC button to return to the previous menu.

UPS Status Information

The status information field provides key information on the status of the UPS.

The **Standard** menu will allow the user to select one of the four screens listed below. Use the UP/DOWN buttons to scroll through the screens.









The **Advanced** menu will scroll through the four screens automatically.

- Input Voltage
- Output Voltage
- Output Frequency
- Runtime

In the case of an UPS event, status updates will be displayed defining the event or condition that has occurred.

The display screen illuminates amber to indicate a warning and red to indicate an alarm depending on the severity of the event or condition.

The icons on the LCD display interface screen may vary depending on the installed firmware version.

	Load icon: The approximate load capacity percentage is indicated by the number of illuminated load bar sections. Each bar represents approximately 16% of the load capacity.
	Mute icon: Indicates the audible alarm is disabled/muted.
Operation Mode Icons	
	On-Line mode: The UPS is supplying conditioned mains power to connected equipment.
	Bypass mode: In Bypass mode, the connected equipment will receive mains power as long as the input voltage and frequency are within the configured limits.
	Green mode: In Green mode, the connected equipment will receive mains power directly. In the event of a mains power outage, there will be an interruption in power to the connected equipment (up to 10 ms) while the UPS switches to On-Line mode or Battery mode. When enabling Green mode, consideration should be given to devices that may be sensitive to power fluctuations.
	Battery mode: The UPS is supplying battery power to connected equipment.
	UPS output off: The UPS is not supplying power to the connected equipment.
Battery Status Icons	
	Battery Charge Status: Indicates the battery charge status. Each illuminated bar represents approximately 20% charge.
	Battery Charge In Progress: Indicates the battery is charging.

Menu overview

The UPS Display Interface has **Standard** and **Advanced** menu screens. The preference for **Standard** or **Advanced** menu selections is made during initial installation and can be changed at any time through the **Configuration** menu.

The **Standard** menus include the most commonly used options.

The **Advanced** menus provide additional options.

Note: Actual menu screens may differ by model and firmware version.

UPS Menu Overview

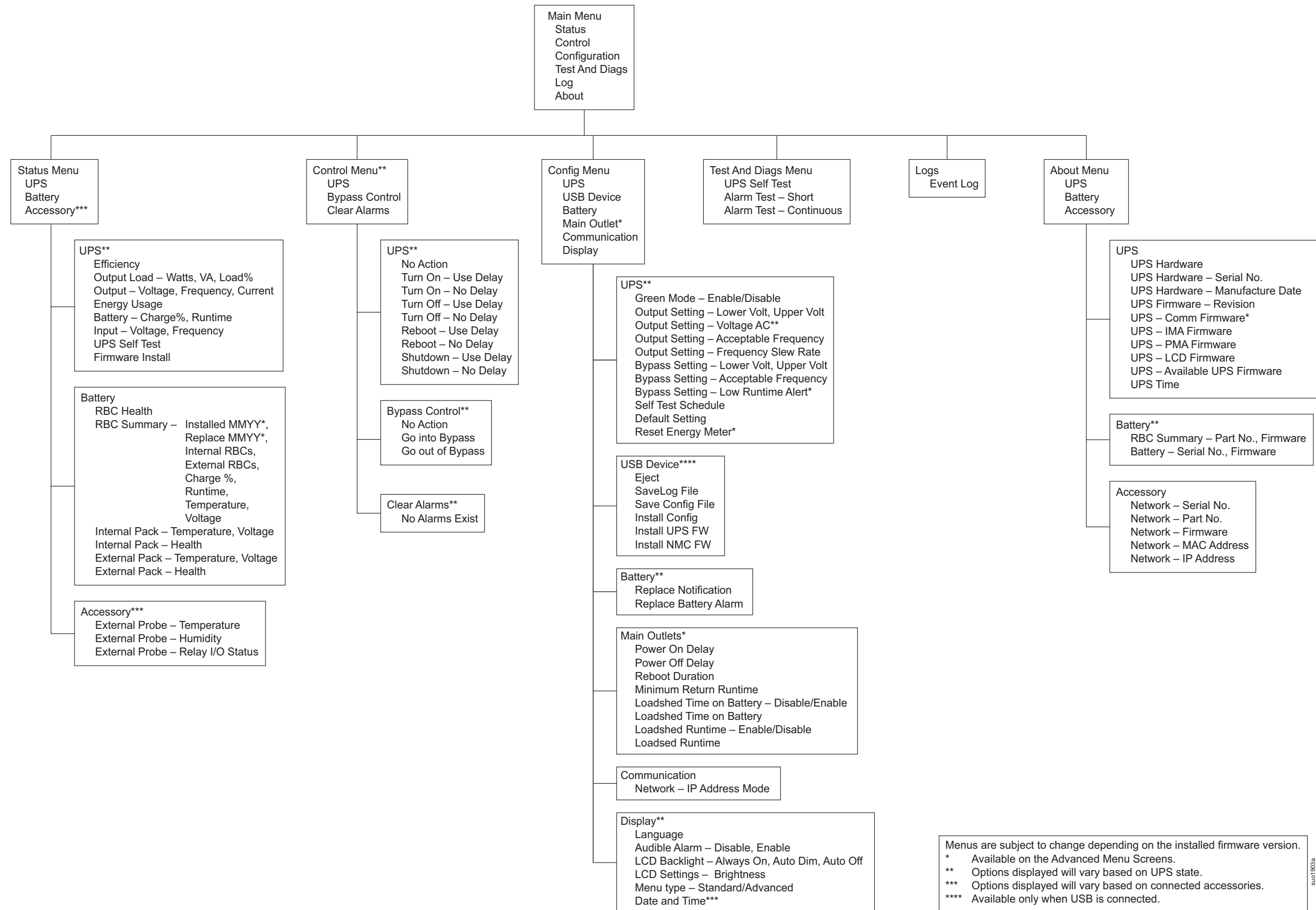

Menus are subject to change depending on the installed firmware version.
 * Available on the Advanced Menu Screens.
 ** Options displayed will vary based on UPS state.
 *** Options displayed will vary based on connected accessories.
 **** Available only when USB is connected.

Configuration

There are three ways to select UPS configuration options.

1. The first time the UPS is turned on the **Setup Wizard** screen will open. On each menu screen select the desired settings. Press OK after each UPS setting is selected.
The UPS will not turn *on* until the setup is completed.
2. **Main Menu** → **Configuration** → **UPS** → **Default Setting**. This screen allows the user to reset the UPS to factory (default) settings. Press OK after the UPS setting is selected.
Refer to “Configuration” on page 15 and UPS Menu Overview for details.
3. Configure settings using an external interface, such as the Network Management Web interface.

Startup configuration

Note: The configuration menu options vary according to the UPS models.

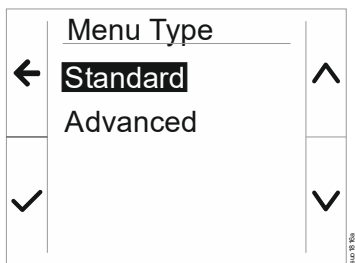
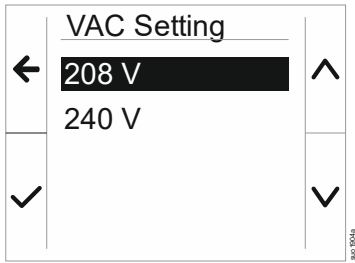
Function	Description
	<p>Select the language required for the display interface. Language options will vary by model and firmware version.</p> <p>Options:</p> <ul style="list-style-type: none"> • English • Français • Italiano • Deutsch • Espanol • Portugues • Japanese • Russian
	<p>The Standard menu options are the most commonly used options. The Advanced menu options will be used by IT professionals who need detailed configuration and reporting information.</p>
	<p>Select the output voltage. NOTE: Options will vary by model.</p> <p>Options:</p> <ul style="list-style-type: none"> • 200 VAC • 208 VAC • 220 VAC • 230 VAC • 240 VAC

General settings

Configure these settings at any time, using the display interface, or the Network Management Web Interface.

	Parameters	Default Value	Options	Description
Config Menu UPS	Green Mode	Disabled	<ul style="list-style-type: none"> • Disable • Enable 	Disable or enable Green mode operation
	AC Setting	Not set (see description)	<ul style="list-style-type: none"> • 2UI models: 220 V, 230 V, 240 V • 2UT models: 208 V, 240 V • 2UJ models: 200 V 	<p>Set the output voltage for the UPS. This setting can only be changed when the UPS output is off.</p> <p>These settings may vary depending on the UPS model.</p> <p>Default Value:</p> <p>The value should be selected by the user during the initial startup. Reset to factory default does not change the selected value.</p>
	Output Lower Acceptable Voltage	192 V for 200 V output 192 V for 208 V output 198 V for 220 V output 207 V for 230 V output 216 V for 240 V output	200 V: 187 to 192 V 208 V: 187 to 192 V 220 V: 187 to 198 V 230 V: 195 to 207 V 240 V: 204 to 216 V	If the UPS input voltage is between the lower acceptable voltage and the higher acceptable voltage, the UPS will operate in Green mode, when enabled.
	Output Upper Acceptable Voltage	216 V for 200 V output 220 V for 208 V output 242 V for 220 V output 253 V for 230 V output 264 V for 240 V output	200 V: 216 to 228 V 208 V: 220 to 235 V 220 V: 242 to 253 V 230 V: 252 to 265 V 240 V: 264 to 270 V	If the output voltage goes outside the acceptable range the UPS will switch from Green mode to On-Line mode or to Battery mode.
	Output Frequency	Auto 50/60 ± 3Hz	<ul style="list-style-type: none"> • Auto 50/60 ± 3 Hz • 50 ± 0.1 Hz • 50 ± 3.0 Hz • 60 ± 0.1 Hz • 60 ± 3.0 Hz 	Set the output frequency for the UPS.
	Output Frequency Slew Rate	1 Hz/sec	<ul style="list-style-type: none"> • 1 Hz/sec • 2 Hz/sec • 4 Hz/sec 	Select the rate of change for output frequency in Hz per second.
	Bypass Lower Acceptable Voltage	160 V	200 V: 160 to 184 V 208 V: 160 to 184 V 220 V: 160 to 184 V 230 V: 160 to 184 V 240 V: 160 to 184 V	If the UPS input voltage is between the lower acceptable voltage and the higher acceptable voltage, the UPS will operate in Bypass mode, when enabled.
	Bypass Upper Acceptable Voltage	240 V for 200 V output 250 V for 208 V output 255 V for 220 V output 265 V for 230 V output 270 V for 240 V output	200 V: 216 to 260 V 208 V: 220 to 250 V 220 V: 242 to 264 V 230 V: 253 to 270 V 240 V: 264 to 270 V	
	Bypass Setting Acceptable Frequency	Wider Frequency 47 - 63 Hz	<ul style="list-style-type: none"> • Wider Frequency 47 - 63 Hz • Use Output Frequency Setting 	The setting Wider Frequency , enables Bypass mode operation for an input frequency range of 47-63 Hz.
Low Runtime Alert	150 seconds	120 to 3600 seconds	The UPS will emit an audible alarm when the remaining runtime has reached this threshold.	

	Parameters	Default Value	Options	Description
Config Menu UPS	Self Test Schedule	Startup + 14 days since last test	<ul style="list-style-type: none"> • Never • Startup • Startup + 14 days since last test • Startup + 7 days since last test 	This is the interval at which the UPS will execute a Self Test .
	Default Setting	No	<ul style="list-style-type: none"> • Yes • No 	Allows the user to restore the UPS factory default settings.
	Reset Energy Meter	No	<ul style="list-style-type: none"> • Yes • No 	<p>The Energy Meter stores information on UPS output energy usage.</p> <p>The Reset feature allows the user to reset the Energy Meter to 0 kWh.</p>
Config Menu Battery	Replacement Notification Time	183 days	<ul style="list-style-type: none"> • 0-730 days • -1 	<p>To set the Near End of Life notification/alarm, select the number of days before the estimated battery end of life. When this date is reached the UPS will emit an audible alarm and a message will appear on the display interface screen.</p> <p>Example: Using the default value, the Near End of Life notification/alarm will occur 183 days before the estimated end of life date.</p> <p>To disable the notification/alarm select -1.</p>
	Replacement Alarm Reminder	14 days	<ul style="list-style-type: none"> • 0-365 days • -1 	<p>The Near End of Life audible alarm can be muted. Enter the number of days between the time a Near End of Life alarm is acknowledged and the next Near End of Life alarm occurs.</p> <p>To disable the notifications select -1.</p>
Config Menu Display	Language	English	<ul style="list-style-type: none"> • English • Francais • Italiano • Deutsch • Espanol • Portugues • Japanese • Russian 	<p>Select the language required for the display interface.</p> <p>Language options will vary by model and firmware version.</p>
	Audible Alarm	Enabled	<ul style="list-style-type: none"> • Disable • Enable 	When audible alarms are disabled, the UPS will never emit an audible alarm.

	Parameters	Default Value	Options	Description
Config Menu Display	LCD Back Light	Auto Dim	<ul style="list-style-type: none"> • Always On • Auto Dim • Auto Off 	<p>To conserve energy, the LCD back light illumination dims or turns off when no events are active.</p> <p>Full display interface illumination gets on when the UPS changes status as a result of an event or when any button on the display interface is pressed.</p>
	LCD Setting Brightness	Medium	<ul style="list-style-type: none"> • Low • Medium • High • Ultra High 	Adjust the brightness of the LCD back light.
	Menu Type	User Choice	<ul style="list-style-type: none"> • Standard • Advanced 	<p>The Standard menus include the most commonly used options.</p> <p>The Advanced menu options include all parameters.</p>
Config Menu Display	Time	UTC time Universal Time Coordinated (UTC) is a coordinated time scale, maintained by the Bureau International des Poids et Mesures (BIPM)]	DD-MMM-YYYY HH:MM:SS am/pm	Scroll through the fields to set the time.
Config Menu Main Outlet	Power On Delay	0 seconds	0-1800 seconds	Select the delay time the main outlet groups will wait between receiving the command to turn on and actual startup.
	Power Off Delay	90 seconds	0-32767 seconds	Select the delay time the main outlet groups will wait between receiving the command to shutdown and actual shutdown.
	Reboot Duration	8 seconds	4-300 seconds	Select the time the main outlet groups will remain off before the UPS will restart.
	Minimum Return Runtime	0 seconds	0-32767 seconds	Select the amount of battery runtime that must be available before the main outlet groups will turn on using battery power, after a shutdown.
	Loadshed On Battery	Disable	<ul style="list-style-type: none"> • Disable • Enable 	<p>To conserve battery power the UPS can disconnect power from main outlet groups not in use.</p> <p>To configure the disconnect delay time for this feature use the Loadshed Time On Battery setting.</p>
	Loadshed Time On Battery	5 seconds	5-32767 seconds	Select the amount of time the main outlet groups will be allowed to function on battery power before shutdown.

	Parameters	Default Value	Options	Description
Config Menu Main Outlet	Loadshed On Runtime	Disable	<ul style="list-style-type: none"> • Disable • Enable 	To conserve battery power the UPS can disconnect power from main outlet groups when the Loadshed Runtime threshold is reached.
	Loadshed Runtime	0 seconds	0-3600 seconds	When the selected runtime threshold is reached the UPS will shutdown the main outlet groups.
Config Menu Communication	IP Address Mode		<ul style="list-style-type: none"> • Manual, • DHCP, • BOOTP 	Scroll through the fields to set the IP address mode and IP address.
	IP Address		<ul style="list-style-type: none"> • Program IP, • Subnet, • Gateway 	

Emergency Power Off

DANGER

RISK OF ELECTRIC SHOCK

Turn *off* the mains input to the UPS and check for hazardous voltages between all terminals including protective earth before working on the UPS or connected equipment.

Failure to follow these instructions will result in death or serious injury.

Overview

The Emergency Power Off (EPO) feature turns *off* power supply to all equipment connected to the UPS, in all modes of operation.

In configurations where multiple units are connected in parallel, each UPS must be connected to the EPO switch.

During an EPO event, the SYSTEM ENABLE switch will move to *off* position.

To power up the connected equipment again, move the SYSTEM ENABLE switch manually to *on* position. After the UPS turns *on*, the user must acknowledge the prior EPO event on the display screen, to continue with normal operation.

Normally open contacts

1. If the EPO switch or relay contacts are normally open, insert the wires from the switch or contacts at pins 1 and 4 of the EPO terminal block. Use 16-28 AWG wire.
2. Tighten the screws to secure the wires.

If the contacts are closed, the UPS will turn OFF and power will be removed from the connected equipment.

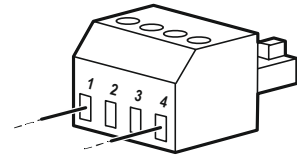

Normally closed contacts

1. If the EPO switch or relay contacts are normally closed, insert the wires from the switch or contacts at pins 1 and 2 of the EPO terminal block. Use 16-28 AWG wire.
2. Insert a wire jumper between pins 1 and 4. Tighten the screws of pins 1, 2, and 4 to secure the wires.

If the contacts are opened, the UPS will turn *off* and power will be removed from the connected equipment.

NOTE: Pin 4 is the power source for the EPO circuit, it provides a few milliamperes of 24 V power.

If the normally closed (NC) EPO configuration is used, the EPO switch or relay should be rated for “dry” circuit applications. The switch or relay contact rating should be for low voltage and low current applications. This normally implies the contacts are gold plated.

The EPO interface is a Safety Extra Low Voltage (SELV) circuit. Connect the EPO interface only to other SELV circuits. The EPO interface monitors circuits that have no determined voltage potential. SELV circuits are controlled by a switch or relay properly isolated from mains power. To avoid damage to the UPS, do not connect the EPO interface to any circuit other than a SELV circuit.

Use one of the following cable types to connect the UPS to the EPO switch.

- CL2: Class 2 cable for general use.
- CL2P: Plenum cable for use in ducts, plenums, and other spaces used for environmental air.
- CL2R: Riser cable for use in a vertical run in a floor to floor shaft.
- CLEX: Limited use cable for use in dwellings and for use in raceways.
- Installation in Canada: Use only CSA certified, type ELC, (extra low voltage control cable).
- Installation in countries other than Canada and the USA: Use standard low voltage cable in accordance with national and local regulations.

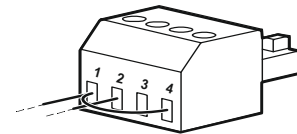

Network Management Interface

Introduction

The UPS has a network port and console port that can be used to access the Network Management Interface.

The Network Management Interface have the same firmware, operation modes and interaction with other APC products such as PowerChute Network Shutdown.

Features

The Network Management Interface allows the UPS to function as a Web based, IPv6 ready product.

The Network Management Interface can manage the UPS using multiple open standards such as:

Hypertext Transfer Protocol (HTTP)	Secure SHell (SSH)
Simple Network Management Protocol versions 1 and 3 (SNMPv1, SNMPv3)	Hypertext Transfer Protocol over Secure Sockets layer (HTTPS)
File Transfer Protocol (FTP)	Secure Copy (SCP)
Telnet	Syslog
RADIUS	



The Network Management Interface:

- Provides UPS control and **Self Test** scheduling features.
- Provides data and event logs.
- Enables set up notifications through event logging, e-mail, and SNMP traps.
- Provides support for PowerChute Network Shutdown.
- Supports using a Dynamic Host Configuration Protocol (DHCP) or BOOTstrap Protocol (BOOTP) server to provide the network (TCP/IP) values.
- Supports use of Remote Monitoring Service (RMS).
- Provides the ability to export a user configuration (.ini) file from a configured UPS, to one or more unconfigured UPS without conversion to a binary file.
- Provides a selection of security protocols for authentication and encryption.
- Communicates with StruxureWare Central and InfraStruxure Manager.
- Supports one universal input/output port for connection to a:
 - Temperature probe, AP9335T (supplied)
 - Temperature/humidity sensor, AP335TH (optional)
 - Relay input/output connector that supports two input contacts and one output relay, AP9810 Dry Contact I/O Accessory (optional)

Related Documents

For related documents refer our web site, www.apc.com.

IP Address Configuration

The default TCP/IP configuration setting DHCP, assumes that a properly configured DHCP server is available to provide TCP/IP settings to the Network Management Interface.

If the Network Management Interface obtains an IPv4 address from a DHCP server, use the UPS Display Interface menus About → Accessory → Network, to see the address.

To setup a static IPv4 address use the display interface Config menu. Set the IP address Subnet Mask and Gateway from the Config menu.

Upgrade Firmware

The firmware of the UPS, RBM and XLBPs can be updated using web-interface, which is built into the UPS network management card. The encrypted image of each subsystem is combined into a single, digitally signed binary image, to provide an advance level of security and tamper proofing.

- Be sure that the Network Management Card is configured and connected to the network.
- Login to the web interface with a valid Username and password.
- Read the firmware upgrade release notes and be sure the compatibility of the new firmware image with the UPS model and the existing firmware version.
- Be sure that adequate battery backup is available before initiating the firmware update.
- Go to the Firmware update section in the web interface, select the valid signed binary image and initiate the update. It may take several minutes for the update(s) to be installed.
- Verify the firmware version in the About menu to be sure that the firmware update was successful.

Smart Battery Management

Definitions

- **Replaceable Battery Module (RBM):** A string of battery cells arranged to produce a battery assembly with a connector. Replacement RBMs can be ordered from our web site, www.apc.com.
- **External Battery Pack (XLBP):** An enclosure that contains RBM(s) and battery management electronics.
- **User Interface (UI):** An interface by which a user can interact with the system. This may include an UPS display interface, a network management interface or PowerChute™ Network Shutdown software.

Note: Do not use a RBM that is not approved by APC.

The system will not detect the presence of a non APC approved battery module and may adversely affect the operation of the system.

Use of a non APC approved RBM will void the manufacturer warranty.

Maintenance

- **RBM maintenance:** The APC RBM uses Lithium ion battery cells and does not require maintenance.
- **Runtime Test (Calibration):** This should be performed anytime the steady state load is changed significantly, for example a new server is added to or removed from the connected load.
- **Battery health monitoring:** The battery energy output and voltage are monitored to assess the health of the installed batteries when the UPS is operating on battery.
Battery health monitoring is done during a **UPS Self Test**, a **Runtime Test (Calibration)**, and when the UPS is operating on battery power.

End of useful life

- **Near end of life notification:** An alert message will appear on the UPS display interface screen when a RBM is approaching the end of its useful life. For configuration details, refer to “Replacement Notification Time” on page 17 and “Replacement Alarm Reminder” on page 17.
The estimated replacement date for each RBM is available through the UI.
- **Needs replacement notification:** The UPS display interface screen shows when RBM replacement is required. The RBM must be replaced as soon as possible.
When an RBM requires replacement, the UPS display interface may recommend that additional RBMs be replaced if they will soon reach the end of their useful life.

Note: Continued operation after the Needs replacement notification may cause damage to the batteries.

Recycling the RBM

1. Remove the RBM from the XLBP.
2. Recycle the RBM.
CAUTION: Do not disassemble the RBM.

Recommended actions after installing new RBM or XLBP

The following actions should be performed after installing a new RBM or XLBP:

- When a new XLBP is installed, the **Battery status LED** illuminates green in both the RBMs indicating that the XLBP is detected by the system and is working normally.
If **Battery status LED** illuminates either Red or Yellow in either of the RBMs, refer to “User interface” on page 24 for details.
- Verify that the UPS is connected to input power and output power is turned on.
 - Go to the UPS display interface, use the status menus to verify that the UPS recognizes the RBMs.
 - Be sure that the connected load to the UPS is greater than 400 watts. This information will appear on the UPS display interface.
 - Perform a **Discharge Test**.

- If at the time of XLBP installation, UPS input power is not available, turn on the UPS output from battery power for 30 seconds. This will allow the UPS to detect all installed RBMs or XLBPs. Refer to “Turn the UPS on/off” on page 11 for instructions on how to turn the UPS on and off.
- Allow the system to charge for 24 hours to ensure full runtime capability.
- Initiate a **Runtime Calibration Test** through the User Interface (UI).

For details on the following tests refer to the Test and Diagnostics Menu options:

- Self Test
- Runtime Test

User interface

View Status/Error notifications: The status of connected XLBPs can be viewed using the UPS display interface menu options.

Battery status LED: The **Battery status LED** indicates three possible states.

- **Is not illuminated:** The battery module is in sleep state. This is the default state.
- **Illuminates red:** An internal error has been detected in the RBM.
- **Flashing red:** Battery module unable to communicate with the UPS.
- **Illuminates green:** Battery module operating normally.
- **Illuminates yellow:** Check the LCD display on the UPS. If the battery mode icon is displayed on the LCD display, then the battery is discharging. Otherwise, an internal error in the RBM has been detected.

To clear the detected internal error

1. Disconnect RBM by disengaging the thumbscrew (located on the front panel of the RBM).
2. Be sure that Battery status LED is not illuminating.
3. Tighten the thumbscrew to connect the RBM.

- If the problem persists even after 3 attempts, then contact Customer Support.

System interfaces: Battery status, alerts, and measurements are shown on the UPS display interface screen.

Replace the RBM in UPS

A RBM should only be disconnected or removed from the UPS temporarily as part of the battery replacement procedure.

1. Remove the front bezel of the Uninterruptible Power Supply (UPS).
2. Turn the battery switch in clockwise direction, using a screwdriver, to switch off the battery.
3. Turn the thumbscrew in counter clockwise direction to unlock the battery module.
4. Push down and hold the thumbscrew downwards and slide out the battery module.
NOTE: Be sure to support the battery using both the hands while sliding out the battery module.
5. Slide the replacement battery module into the UPS till it gets locked in position.
6. Press the thumbscrew till it engages and turn it in clockwise direction to lock the battery.
7. Turn the battery switch in counter clockwise direction, using a screwdriver, to switch on the battery.
8. After installing the RBM, the UPS display interface may prompt the user to verify the status of the replaced battery modules. If the battery module is new, respond YES. If the battery module is not new, respond NO.

XLBP installation and replacement

Refer to the External Battery Pack Installation Guide for installation and replacement instructions.

Troubleshooting



Use the table below to solve minor installation and operation problems.

Refer to our web site, www.apc.com for assistance with complex UPS problems.

The UPS features firmware that can be upgraded.

Go to the our web site, www.apc.com/Support, or contact your local Customer Care Center for more information.

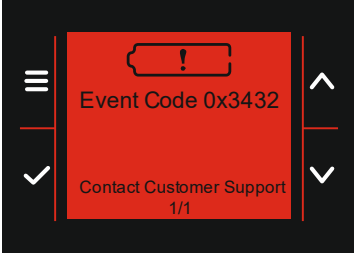
Problem and Possible Cause	Solution
UPS is not turning on or there is no output	
The UPS is not connected to mains power.	Be sure the power cable is securely connected to the UPS and to the mains power supply.
The UPS is connected to mains power.	Be sure that <ul style="list-style-type: none"> • UPS output connections are secured properly. • SYSTEM ENABLE switch is turned <i>on</i>. • Thumbscrew on the battery module is completely engaged.
The UPS display interface screen shows very low or no mains power.	Check the mains power supply to be sure that the power quality is within acceptable limits.
The UPS has detected an internal error.	The UPS Display Interface screen will show a message to identify the alert and corrective action.
UPS emits an audible alarm	
Normal UPS operation when running on battery power.	The UPS is operating on battery power. Refer to the status of the UPS as shown on the UPS Display Interface screen. Press any button to mute all audible alarms.
The UPS emits an audible alarm and the color of the UPS display interface changes to red or amber.	The UPS has detected an internal error. Refer to the display interface screen for information.
UPS does not provide expected backup time	
The UPS batteries are weak due to a recent power outage or they are near the end of service life.	Charge the batteries. Batteries require recharging after extended outages and wear out faster when put into service often or when operated at elevated temperatures. If the batteries are near the end of service life, consider replacing the batteries even if the Replace Battery message is not displayed.
The UPS is experiencing an overload condition.	The connected equipment exceeds the specified maximum load. Refer to our web site, www.apc.com for product specifications. The UPS will emit a sustained audible alarm until the overload condition is corrected. Disconnect nonessential equipment from the UPS to correct the overload condition. NOTE: If the problem still persists, disconnect the UPS from the AC Mains and turn <i>off</i> the SYSTEM ENABLE switch and start up the UPS again.
UPS operates on battery power while connected to mains power	
The input circuit breaker has tripped.	Reduce the load on the UPS. Disconnect nonessential equipment and reset the circuit breaker. Be sure that the circuit breaker is rated for the connected load to the UPS.
There is very high, very low, or distorted input line voltage.	Navigate to the UPS Display Interface screen that shows input voltage. Be sure that the input voltage is within specified operating limits. If no input voltage is indicated on the UPS Display Interface screen, contact Customer Support through our web site, www.apc.com .
The UPS Display Interface screen shows the message Waiting for Minimum Runtime .	The UPS output does not turn on when the battery runtime is lower than the configured <i>Minimum Return Runtime</i> . <ul style="list-style-type: none"> • Wait till the battery gets charged or • Change the <i>Minimum Return Runtime</i> setting through the Config → UPS menu.

Problem and Possible Cause	Solution
UPS Display Interface Status screen shows Overload and the UPS emits an audible alarm	
The UPS is experiencing an overload condition.	Rating of the connected equipment exceeds the capacity of the UPS. The UPS will emit an audible alarm until the overload condition is corrected. Disconnect nonessential equipment from the UPS to correct the overload condition. Note: If the problem still persists, disconnect the UPS from the AC Mains and turn <i>off</i> the SYSTEM ENABLE switch and start up the UPS again.
UPS Display Interface Status screen shows UPS is operating in Bypass mode	
The UPS received a command to operate in Bypass mode	No action is required.
The UPS has detected an internal error. The UPS has automatically switched to Bypass mode.	The UPS Display Interface screen will show a message to identify the alert and corrective action.
UPS Display Interface is red or amber and shows an alert message The UPS emits an audible alarm	
The UPS has detected an internal error normal operation.	Follow the instructions on the UPS Display Interface screen. Press any key to mute all audible alarms.
The UPS Display Interface screen shows the message Disconnected Battery .	Be sure that the RBM is completely inserted, the thumbscrew is completely engaged and the BATTERY ON/OFF switch is turned <i>on</i> . Perform a UPS Self Test to be sure the UPS detects all connected RBM/ XLBPs. To perform a UPS Self Test use the UPS Display Interface menu option Test and Diagnostics .
The UPS Display Interface screen shows the message Replace Battery .	Replace all the RBMs. Contact customer support.
The UPS display turns red or amber, displays an alert message, and emits a sustained audible alarm Red illumination indicates an UPS alarm that requires immediate attention Amber illumination indicates an UPS alarm that requires attention	
There is an internal UPS alert. 	Do not attempt to use the UPS. Turn the UPS <i>off</i> and have it serviced immediately.
The UPS is experiencing an overload condition. 	Reduce the load on the UPS. Disconnect nonessential equipment.
The Replace Battery alert is displayed	
The battery has a weak charge.	Allow the battery to recharge for at least four hours. Then, perform a Self Test . If the problem persists after recharging, replace the battery.
The replacement battery is not properly connected.	Be sure that the RBM is completely inserted, the thumbscrew is completely engaged and the BATTERY ON/OFF switch is turned <i>on</i> .

Transport

1. Shut down and disconnect all connected equipment.
2. Disconnect the unit from mains power.
3. Disconnect the RBM and all the XLBPs (if applicable).
4. Follow the shipping instructions outlined in the *Service* section of this manual.

Service

If the unit requires service, do not return it to the dealer. Follow these steps:

1. Review the “Troubleshooting” on page 25 section of the manual to eliminate common problems.
2. If the problem persists, contact Customer Support through our web site, **www.apc.com**.
 - a. Note the model number and serial number and the date of purchase. The model and serial numbers are located on the regulatory label on the top of the unit and are available through the LCD display on select models.
 - b. Call Customer Support. A technician will attempt to solve the problem over the phone. If this is not possible, the technician will issue a Returned Material Authorization Number (RMA#).
 - c. If the unit is under warranty, the repairs are free.
 - d. Service procedures and returns may vary internationally. For country specific instructions refer to the APC web site, **www.apc.com**.
3. Shipment of Lithium Ion Battery is highly regulated and the regulation is evolving. Pack the battery and UPS separately.
4. Always contact Customer Support to get the latest guidance on shipment of Lithium ion battery and UPS.
5. Pack the unit properly to avoid damage in transit. Do not use foam beads for packaging. Damage sustained in transit is not covered under warranty.
6. Write the RMA# provided by Customer Support on the outside of the package.
7. Return the unit by insured, prepaid carrier to the address provided by Customer Support.

Limited Factory Warranty

Schneider Electric IT Corporation (SEIT), warrants its products to be free from defects in materials and workmanship for a period of five (5) years from the date of purchase. The SEIT obligation under this warranty is limited to repairing or replacing, at its own sole option, any such defective products. Repair or replacement of a defective product or part thereof does not extend the original warranty period.

This warranty applies only to the original purchaser who must have properly registered the product within 10 days of purchase. Products may be registered online at warranty.apc.com.

SEIT shall not be liable under the warranty if its testing and examination disclose that the alleged defect in the product does not exist or was caused by end user or any third person misuse, negligence, improper installation, testing, operation or use of the product contrary to SEIT recommendations of specifications. Further, SEIT shall not be liable for defects resulting from: 1) unauthorized attempts to repair or modify the product, 2) incorrect or inadequate electrical voltage or connection, 3) inappropriate on site operation conditions, 4) Acts of God, 5) exposure to the elements, or 6) theft. In no event shall SEIT have any liability under this warranty for any product where the serial number has been altered, defaced, or removed.

EXCEPT AS SET FORTH ABOVE, THERE ARE NO WARRANTIES, EXPRESS OR IMPLIED, BY OPERATION OF LAW OR OTHERWISE, APPLICABLE TO PRODUCTS SOLD, SERVICED OR FURNISHED UNDER THIS AGREEMENT OR IN CONNECTION HEREWITH.

SEIT DISCLAIMS ALL IMPLIED WARRANTIES OF MERCHANTABILITY, SATISFACTION AND FITNESS FOR A PARTICULAR PURPOSE.

SEIT EXPRESS WARRANTIES WILL NOT BE ENLARGED, DIMINISHED, OR AFFECTED BY AND NO OBLIGATION OR LIABILITY WILL ARISE OUT OF, SEIT RENDERING OF TECHNICAL OR OTHER ADVICE OR SERVICE IN CONNECTION WITH THE PRODUCTS.

THE FOREGOING WARRANTIES AND REMEDIES ARE EXCLUSIVE AND IN LIEU OF ALL OTHER WARRANTIES AND REMEDIES. THE WARRANTIES SET FORTH ABOVE CONSTITUTE SEIT'S SOLE LIABILITY AND PURCHASER EXCLUSIVE REMEDY FOR ANY BREACH OF SUCH WARRANTIES. SEIT WARRANTIES EXTEND ONLY TO ORIGINAL PURCHASER AND ARE NOT EXTENDED TO ANY THIRD PARTIES.

IN NO EVENT SHALL SEIT, ITS OFFICERS, DIRECTORS, AFFILIATES OR EMPLOYEES BE LIABLE FOR ANY FORM OF INDIRECT, SPECIAL, CONSEQUENTIAL OR PUNITIVE DAMAGES, ARISING OUT OF THE USE, SERVICE OR INSTALLATION OF THE PRODUCTS, WHETHER SUCH DAMAGES ARISE IN CONTRACT OR TORT, IRRESPECTIVE OF FAULT, NEGLIGENCE OR STRICT LIABILITY OR WHETHER SEIT HAS BEEN ADVISED IN ADVANCE OF THE POSSIBILITY OF SUCH DAMAGES. SPECIFICALLY, SEIT IS NOT LIABLE FOR ANY COSTS, SUCH AS LOST PROFITS OR REVENUE, WHETHER DIRECT OR INDIRECT, LOSS OF EQUIPMENT, LOSS OF USE OF EQUIPMENT, LOSS OF SOFTWARE, LOSS OF DATA, COSTS OF SUBSTITUANTS, CLAIMS BY THIRD PARTIES, OR OTHERWISE.

NOTHING IN THIS LIMITED WARRANTY SHALL SEEK TO EXCLUDE OR LIMIT SEIT LIABILITY FOR DEATH OR PERSONAL INJURY RESULTING FROM ITS NEGLIGENCE OR ITS FRAUDULENT MISREPRESENTATION OF TO THE EXTENT THAT IT CANNOT BE EXCLUDED OR LIMITED BY APPLICABLE LAW.

To obtain service under warranty you must obtain a Returned Material Authorization (RMA) number from customer support. Customers with warranty claims issues may access the SEIT worldwide customer support network through the APC web site: www.apc.com. Select your country from the country selection drop down menu. Open the Support tab at the top of the web page to obtain information for customer support in your region. Products must be returned with transportation charges prepaid and must be accompanied by a brief description of the problem encountered and proof of date and place of purchase.

APC Worldwide Customer Support

Customer support for this or any other APC product is available at no charge in any of the following ways:

- Visit the our web site to access documents in the APC Knowledge Base and to submit customer support requests.
 - **www.apc.com** (Corporate Headquarters)
Connect to localized APC web site for specific countries, each of which provides customer support information.
 - **www.apc.com/support/**
Global support searching APC Knowledge Base and using e-support.
- Contact the APC Customer Support Center by telephone or e-mail.
 - Local, country specific centers: go to **www.apc.com/support/contact** for contact information.
 - For information on how to obtain local customer support, contact the our representative or other distributor from whom you purchased your APC product.



Select models are ENERGY STAR[®] qualified.

For more information on your specific model refer to our web site, www.apc.com.

© 2023 Schneider Electric. Schneider Electric, Life is On | Schneider Electric, the Schneider Electric logo, APC, the APC logo and Smart-UPS are owned by Schneider Electric SE or their affiliated companies. All other trademarks are property of their respective owners.